

Features

- : Multi-mode 850nm VCSEL
- : 1.25 / 2.5 Gbps data rates
- : Low Drive current and voltage
- : Ball Lens Type TO-46 Can Package
- : Other configurations available on request

Applications

- : High speed Data Communications
- : Gigabit Ethernet
- : Fiber Channel

Description

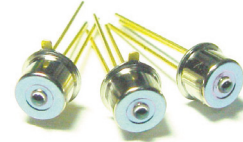

Absolute Maximum Ratings

Parameter	Rating
Storage Temperature	-40 to 100 °C
Operating Temperature	0 to 85 °C
Lead Solder Temperature	260 °C, 10 sec
Continuous Forward Current	12mA
Continuous Reverse Voltage	5V (@10µA)

Dimensions

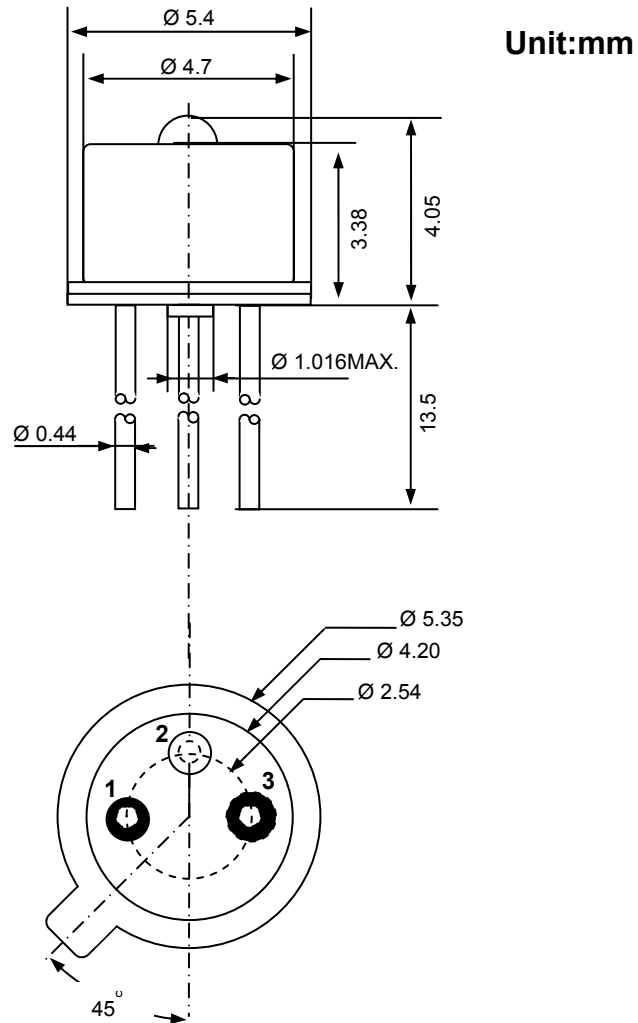

PINOUT

Number	PM85-B1P0N
1	LD Anode
2	NC
3	LD Cathode

Electro-Optics Characteristics (T_a=25°C unless otherwise stated)

Parameters	Symbol	Specified			Unit	Test Conditions
		Min.	Typ.	Max.		
Threshold Current	I _{th}		1.5	3	mA	CW
I _{th} Temperature Variation	ΔI _{th}		1.5		mA	T _a =0 to 85 °C
Slope Efficiency	η	0.3	0.4	0.6	W/A	I _f = 6 mA
η Temperature Coefficient	Δη / ΔT		-0.5		%/ °C	T _a =0 to 85 °C at 6 mA
Optical Output Power	P _o		2.0		mW	I _f = 6 mA
Peak Wavelength	λ _p	840	850	860	nm	I _f = 6mA
λ _p Temperature Coefficient	Δλ / ΔT		0.06		nm/ °C	T _a =0 to 85 °C at 6mA
Spectral Bandwidth (RMS)	Δλ			0.85	nm	I _f = 6mA
Forward Voltage	V _f		1.7	2.2	V	I _f = 6mA
Breakdown Voltage	V _b		-10		V	
Dynamic Resistance	R _d	20	35	55	Ohm	I _f = 6mA
Focal Length	F _D		2.5		mm	

Notes

* These specifications are subject to change without notice

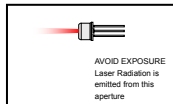
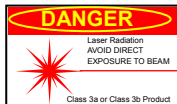

NOTICE

The inherent design of this component causes it to be sensitive to electrostatic discharge(ESD). To prevent ESD-induced damage and/or degradation to equipment, take normal ESD precautions when handling this product

DANGER

The VCSEL is a class IIIb laser and should be treated as a potential eye hazard. Due to the size of the component, the applicable warning logotype, aperture label, and certification / identification label cannot be placed on the component itself.

Characteristics Curves

LIV Curve

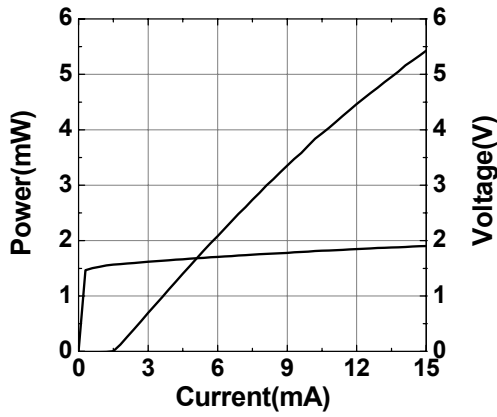

LIV vs Temperature

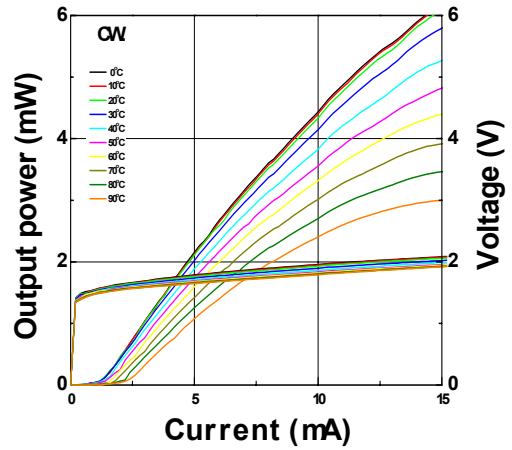

EL Spectrum

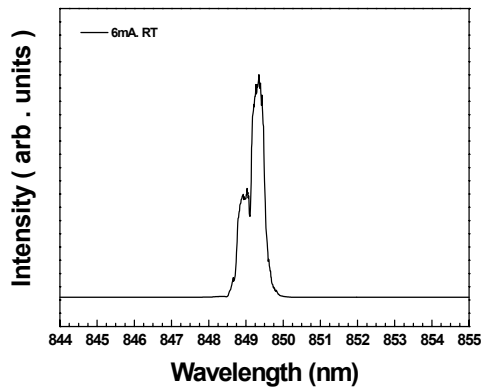

I_{th} vs Temperature

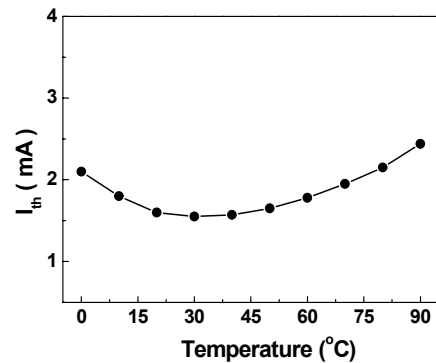

Eye diagram

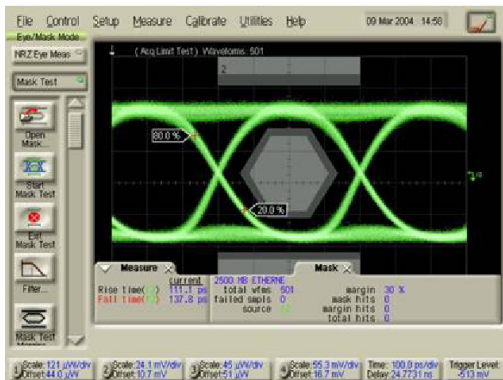

Eye diagrams at 6mA Data rate : 2.5Gbps
 Extinction ratio : 10dB PRBS : 2³¹-1
 Filtered 1.87G Low pass filter Back to Back